

ELAFLEX Hose Reels are supplied as a complete customised package incl. our hoses, couplings and nozzles.

Hose Reels 'Modular Line G and GB 25/38' as manual or motorised, used for retraction of Elaflex hoses up to 40 m in max. DN 38 or 70 m in max. DN 25.

It can be supplied with different rewind systems (manual, electric, hydraulic and pneumatic), resistant materials and swivel joints.

Suitable for a wide range of media, e.g. gasoline, diesel, aviation fuels, urea solution (AdBlue®), detergents, solvents, oils, water, gases and others. For example: HD 38 with ZV 400 for ship refuelling.

Standard versions are supplied with open disks.

CUSTOMISED VERSION

Drum diameter and disc distance can be customised to meet special requirements.

MATERIALS

Frame: available in polyester powder coated carbon steel, UV resistant (on request: cataphoresis treatments or zinc plated) or stainless steel (AISI 304 or AISI 316L).

Wet parts: available in carbon steel or stainless steel (AISI 304 or AISI 316L).

Swivel joint: available in carbon steel (zinc plated), brass or stainless steel (AISI 303 / AISI 316L), in 90° or straight shape*).

Working pressure up to 200 bar*).

Temperature range -40° to +120° C*).







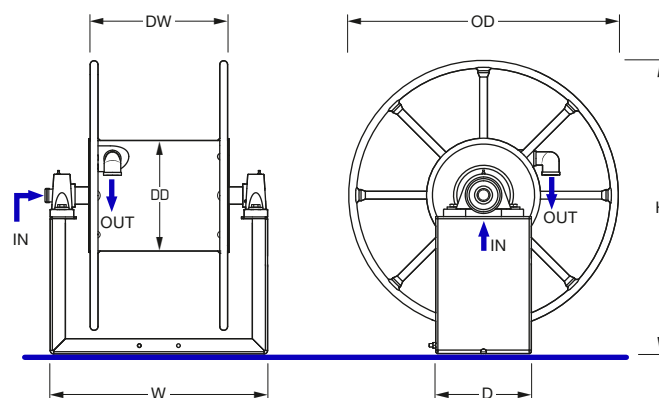

*) depending on materials

COLOURS



DIMENSIONS



							
Recommended Hose	Connections	Drum Diameter	Disc Diameter	Distance btw the disks	Dimensions	Weight	Standard Part Number
max. Length	IN / OUT	DD Ø mm	OD Ø (mm)	DW (mm)	W x D x H (mm)	kg	Type
35 m	1" bsp female / 1" bsp female	310	620	280	500x620x675	-	HR ML GB 25 L35
18 m	1½" bsp female / 1½" bsp female	310	620	280	500x620x690	-	HR ML GB 38 L18
70 m	1" bsp female / 1" bsp female	310	750	380	600x750x805	-	HR ML G 25 L70
40 m	1½" bsp female / 1½" bsp female	310	750	380	600x750x820	-	HR ML G 38 L40

1) Hose Reels dimensions without swivel joint and rewind system.

2) Please contact our sales team to check capacity when smaller hose diameters are required.

SWIVEL JOINTS

90° SWIVEL JOINT (1)

DN 1" available in zinc plated carbon steel or stainless steel AISI 303 or brass

DN 1½" available in zinc plated carbon steel

STRAIGHT SWIVEL JOINT (2)

DN 1" available in zinc plated carbon steel
stainless steel AISI 316 L

DN 1½" available in zinc plated carbon steel



REWIND SYSTEMS

MANUAL REWIND (3)

- with lateral handle
- direct drive

options:

- mechanical lock
- friction break
- chain transmission

HYDRAULIC REWIND (4)

- hydraulic motor with operational levers and hydraulic lock
- direct drive

options:

- speed control kit
- chain transmission

THREE PHASE ELECTRIC REWIND (5)

- electric motor 230/400V
- direct drive

options:

- control panel kit
- control panel kit with remote control
- mono phase inverter kit
- chain transmission

on request:

- ATEX 2GD or 3GD

ELECTRIC REWIND (6)

- electric motor 12V or 24V
- direct drive

options:

- control panel kit
- kit on/off
- friction break for "E" motor
- chain transmission

on request:

- ATEX 2GD or 3GD

PNEUMATIC REWIND (7)

- pneumatic motor
- direct drive

options:

- kit on/off
- chain transmission

ACCESSORIES

HOSE GUIDE KIT (8)

AUTOMATIC HOSE GUIDE KIT (9)

KIT FOR DISKS CLOSURE (10)

(recommended for motorised systems)

