

# DEF NOZZLE w/o Misfilling Prevention

EN 13012/P-TÜ7-01930/TÜV P-TÜ7-8113338228  
Ⓢ II 1 G Ex h IIA Ga TPS 19  
ATEX 103415 0002 U

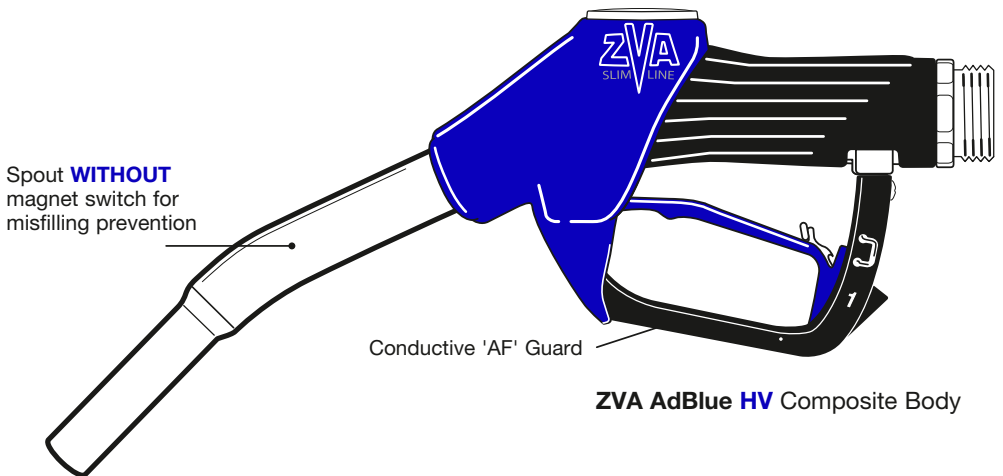

Heavy **V**ehicle refilling with DEF ("Diesel Exhaust Fluid"/urea solution).  
Meets compatibility testing against DEF contamination to ISO 22241-1.

## AUTOMATIC SAFETY NOZZLE INSTALLATION AND OPERATING MANUAL

english

## DESCRIPTION AND PUTTING INTO SERVICE

The DEF nozzle **ZVA AdBlue HV** Composite Body without misfilling prevention ('Heavy Vehicles' such as road tankers, busses etc.) is a dispensing nozzle with an automatic safety shut off for heavy vehicle refilling with DEF urea solution to ISO 22241-1 ("Diesel Exhaust Fluid" DEF / AUS 32 / ARLA 32). Flowrate up to 10 gpm (38 l/min), working pressure 7,5 psi up to 50 psi (0,5 up to 3,5 bar), operating temperature down to -4 °F (-20 °C) only in conjunction with a suitable heating system within the dispenser.

Each nozzle has been subjected to stringent tests before leaving the factory and validated by the applied markings and date code.

The **ZVA AdBlue HV** Composite Body is supplied ready for connection to the hose. When installing a swivel or safety break apply the max. tightening torque of 15 ft \* lb 18.5 ft \* lb (20-25 Nm). After assembling and switching on the pump, point the spout downwards towards the ground and operate the lever (9) several times to vent air from hose and nozzle. Carry out a complete functional testing of the nozzle. Then check:

Is the nozzle, hose connection and swivel tight under pressure?

Does the pump switch off when putting the nozzle back into the nozzle boot?

## PLEASE NOTE

The special type of **ZVA AdBlue HV** Composite Body - DEF NOZZLE w/o Misfilling Prevention is equipped with a standard spout and **WITHOUT** a magnet switch for misfilling prevention to ISO 22241-4 (see marking on spout).

**WARNING:** Unintentional dispensing of DEF (misuse) e.g. into Diesel tanks is possible. That might lead to engine destruction. DEF is not a fuel additive!

The nozzle is either available with fixed hose inlet 'F', swivel EA 075 A or Safety Swivel Break SSB 16 SS of stainless steel to prevent contamination of DEF urea solution.

## APPROVALS / OPERATING CONDITIONS

**ZVA AdBlue HV** Composite Body - DEF NOZZLE w/o Misfilling Prevention is still suitable for the use with filler inlets to ISO 22241-4. The nozzle is type approved to EN 13012 and ATEX certified.



**Note:** The use of the lever latch is not allowed in some countries, special rules might apply. If you are unsure, please contact Elaflex.

## WARNINGS

**Please read this manual carefully before installation or operation of the nozzle.**

**Safety:** For safety reasons, the nozzle shall only be operated with conductive 'AF' guard.

### Avoid Misfilling:

Urea solution is not a fuel additive. Do not dispense the medium into a Diesel tank, but only into a dedicated separate tank.



**Note:** You are at risk of misfilling contamination without using Elaflex DEF nozzle with spout including magnet switch and Elaflex 40 adapter in vehicle DEF tank.

### Corrosion:

Urea solution can cause corrosion. Accidental spills on the car paint or clothes should be wiped off with a damp cloth and further cleaned with water. Keep DEF out of the reach of children. In case of swallowing DEF seek medical help immediately. Avoid direct contact to the skin or eyes as it can lead to irritations.

## HOW THE ZVA AUTOMATIC WORKS (see picture last page)

Due to the flow of DEF through the nozzle a vacuum at the valve seat (6) is created. Air is drawn in through the sensing port (1) at the tip of the spout, through the safety cut-out, past the diaphragm, and into the DEF. The valve will remain open while the air flows freely. When DEF reaches the sensing port, a vacuum builds up rapidly, lifts the diaphragm (4) and the nozzle shuts off automatically by pushing the valve into the closed position against the flow. The automatic shut off is also activated if the ball of the safety cut-out (3) rolls back to block the air passage. It will also occur if the spout is pointed upwards or if the nozzle is dropped onto the ground.

## HINTS FOR PROPER HANDLING

**INSERT THE SPOUT FULLY INTO THE DEF TANK.** The ball of the safety valve rolls forward to open the air passage. This is the best way to refill in DEF.

At some narrow horizontal filler necks this is not possible. The safety cut-out prevents the valve from opening. The ball rolls backwards blocking the air passage and the nozzle trips off continuously.

In this case lift and hold the nozzle so that the ball now rolls forward opening up the air passage. Refilling is now possible when provided nozzle is kept in this position.

**Make sure that the ZVA AdBlue HV** Composite Body **is hooked firmly into the DEF tank so that it cannot slip out during refilling.**

**DO NOT FILL TOO FAST:** Splashing of DEF can shut off the nozzle before the DEF tank is full. Some filler necks are difficult to refill. Reduce the flow rate to avoid blow backs. The flow rate can be adopted to the capacity of the filler neck by the three - speed lever latch.

**First position** 2/2 = Fully opened for well vented, straight and near vertical fill pipes

**Second position** 1/2 = Reduced output for narrower fill pipes

**THE AUTOMATIC SHUT OFF WILL ALSO WORK IF THE LEVER IS HELD OPEN MANUALLY,** according to EN 13012. Once the DEF touches the sensing port (1) the automatic cuts off. Topping up is possible.

**A FEW DROPS OF DEF WILL REMAIN IN THE NOZZLE SENSING PORT (1).** Always tilt the nozzle forward into the DEF tank to drain for a few moments before returning it to the nozzle boot. Then the next user will not be surprised by drips.

## MAINTENANCE

Daily visual inspection of the **ZVA AdBlue HV** Composite Body nozzle by trained personnel should be carried out to ensure proper function. The nozzle shall be clean and not show any signs of damage (e.g. broken components, sharp edges, blocked lever, swivel non-rotating). Especially check the nozzle spout for damages. In case the nozzle spout is polluted by crystallized DEF, soak it in a bucket of warm water to dissolve the crystals.

The nozzle condition shall be thoroughly checked during the annual pump maintenance by competent personnel. Applicable laws, regulations and Codes of Practice have to be followed. Especially check the automatic shut-off and the tightness of the locking mechanism of the spout. Nozzles in unfit condition for use must be replaced immediately.

For repair work clamp the nozzle body in the vice as shown below. For installation of swivel/safety break apply a max. tightening torque of 15 ft \* lb 18.5 ft \* lb (20-25 Nm).



## IN CASE OF TROUBLE

### IF THE NOZZLE FAILS TO OPEN:

Please check if the strainer between the nozzle and hose assembly is clogged. If necessary, remove and clean it using compressed air, then reinstall it.

Also the pump pressure may be too low to push the valve poppet open. If the pump pressure cannot be increased, disconnect the **ZVA AdBlue HV** Composite Body, remove the swivel, pull the lever to the open position and push the valve stem to open the poppet (7).

**IF THE NOZZLE DOES NOT CLOSE AUTOMATICALLY:** The vacuum required to operate the automatic action is too low. With the pump running, fully pull the lever (9) to check that full flow can be obtained. Also check, if a loose spout, damaged vacuum cap (5) or clogged strainer (8) have caused the pressure drop.

**IF THE NOZZLE KEEPS TRIPPING OFF PERMANENTLY:** Check if DEF has crystallized in the spout tip. DEF tends to crystalize. Due to evaporation of water, white crystals will show. If these should block the air passage (a sign for this is that the **ZVA AdBlue HV** Composite Body keeps tripping off continuously), this can be solved easily by putting the nozzle spout in a bucket with warm water. In order to avoid contamination, please rinse the nozzle spout with DEF before the next refilling.

Then check if it is caused by the ball of the safety cut off by shaking the nozzle. If the ball is free to move, it will rattle. To clear the air passage blow compressed air up the spout until air comes out of the sensing port (1).

**If dispensing is not possible due to failed dispenser heating (icing),** first bring back the heating into service. Once a sufficient operation temperature is reached, dispense at least 3-4 litre DEF to restore the full functionality.

**If ZVA AdBlue HV** Composite Body **still does not work properly,** please contact your service contractor or Elaflex.

## GUARANTEE

We guarantee against defective materials and manufacturing up to 18 months from date of supply. If the delivery date cannot be established, the date code on the nozzle (i.e. · 2023 = 1<sup>st</sup> quarter 2023) prevails. Excluded are nozzles and parts subjected to wear and tear, abuse and to contamination.

Furthermore excluded are damages by misuse, indirect damages and costs, travelling related to exchange and repair work. We refuse any liability for consequential loss or damage resulting from the use of our nozzle.

# Certificates

TUEV approval



TÜV NORD Systems GmbH & Co. KG  
 Große Bahnstraße 31 • 22525 Hamburg/Germany  
 Phone +49 40 95 97-2310  
 Fax +49 40 95 97-2285  
 email: [techn@tuv-nord.de](mailto:techn@tuv-nord.de)  
 Reference No. PUZ-HHA02  
[www.tuv-nord.de](http://www.tuv-nord.de)

### General Test Certificate

**Certificate Number:** P-TÜ7-8113338228

**Manufacturer:**  
 ELAFLEX HIBY GmbH & Co.KG  
 Schnackenburgallee 121  
 22525 Hamburg/Germany

**Gegenstand:** Automatic Nozzle

Type "ZVA AdBlue HV" and "ZVA AdBlue LV"  
 (HV - Heavy Vehicle, LV - Light Vehicle)

for dispensing Aqueous Urea Solution (AUS 32) for the filling of AUS 32 vessels in heavy vehicles as well as installations for the filling of transportable vessels with AUS 32 according to ISO 22241-1

**Period of validity:** **31 May 2026**

Hamburg, 19 July 2021

Head of testing and inspection body for automatic nozzles  
 Reference no. HHA02



Based on the present General Test Certificate, the aforementioned object may be used in the sense of the state building code. This General Test Certificate comprises 4 pages and 1 attachment. For this object, the first General Test Certificate was issued in the year 2016. The present Test Certificate supersedes the General Test Certificate P-TÜ7-8113338228 dated 11 May 2016.

Page - 1 - of the General Test Certificate P-TÜ7-8113338228 dated 19. Juli 2021

TUEV approval

ZERTIFIKAT ◆ CERTIFICATE ◆ 証明書 ◆ CERTIFICADO ◆ CERTIFICAT

(1) **EU-Type Examination Certificate**  
TRANSLATION

(2) Component Intended for Use in Potentially Explosive Atmospheres  
**Directive 2014/34/EU**

(3) Number of Certificate of EU-Type Examination:  
**TPS 19 ATEX 103415 0001 U** Issue 01

(4) Product: Safety break  
 Types: SSB 16, PSB 16, SSB 25, CSB 21  
 Special versions: DC, SG, ERS, SS, LV, NR  
 Manufacturer: ELAFLEX HIBY GmbH & Co. KG

(5) Address: Schnackenburgallee 121  
 22525 Hamburg  
 Germany

(6) This product and any acceptable variation thereto are specified in the schedule to this certificate and the documents therein referred to.

(7) TÜV SÜD Product Service as notified body No. 0123 according to article 17 of the guideline 2014/34/EU of the European Parliament and the Council of the European Union certifies that this product has been found to comply with the Essential Health and Safety Requirements relating to the design and construction of products and protective systems intended for use in potentially explosive atmospheres, given in Annex II of the Directive. The examination and test results are recorded in the confidential report 713262412/3.

(8) Compliance with the Essential Health and Safety Requirements has been assured by compliance with:  
**EN ISO 80079-36:2016 EN ISO 80079-37:2016 EN 13617-2:2021**

(9) The sign "U" placed behind the certificate number indicates that this certificate should not be founded with certificates issued for equipment or protective systems. This partial certification may be used as a basis for certification of an equipment or protective systems.

(10) This EU-Type Examination Certificate relates only to the design and the construction of the specified product in accordance with Directive 2014/34/EU. Further requirements of this Directive apply to the manufacturing process and supply of this product.

(11) The marking of the component shall include the following:



**II 1 G Ex h IIA**

and is valid for T<sub>a</sub> = -20°C to +55°C (All Safety Break Variants except Low Temperature "LT" variant)  
 T<sub>a</sub> = -40°C to +55°C (Low Temperature "LT" variant)

Certification Body Explosion Protection  
 Ridlerstraße 65, 80339 Munich

Munich, 23.11.2022

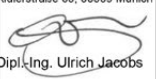

Dipl.-Ing. Ulrich Jacobs

Page 1 / 3



EU-Type Examination Certificate without signature shall not be valid. The certificates may be circulated only without alteration. Extracts or alterations are subject to approval by TÜV SÜD Product Service GmbH. In case of dispute, the German text shall prevail.

The document is internally administrated under the following number: EX5A 103415 0001 Rev. 01

TÜV SÜD Product Service GmbH • Certification Body • Ridlerstrasse 65 • 80339 Munich • Germany



Product Service

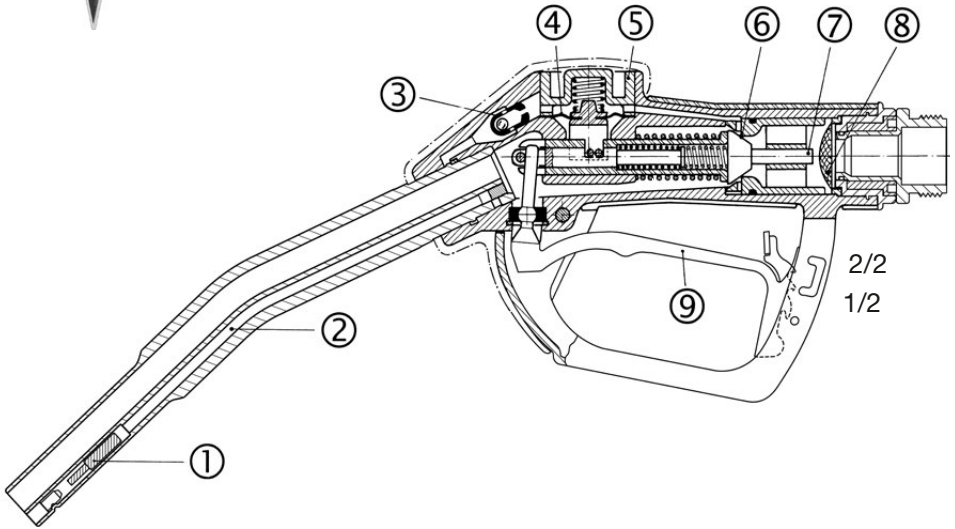

**ZVA AdBlue HV Composite Body**